



CREDA
ACOUSTICAL
WALL PANEL

CREDENCE
We The Trust

World Most trusted 100 % Made In India Brand



BENEFITS

- Excellent Sound absorption (NRC 0.9)
- Available in various sizes & shapes
- Multiple fabric options for aesthetic look
- Easy installation

AREA OF APPLICATION

- Auditoriums, Conferences Rooms
- Seminar Hall, Libraries, Indoor Stadium
- Cinema Hall, Home Theater
- Studio , Study room, Pubs

TECHNICAL DATA



BEST ACOUSTIC
PERFORMANCE



EASY TO CLEAN



FIRE RETARDANT



HUMIDITY
RESISTANCE



MULTIPLE
COLOUR OPTIONS

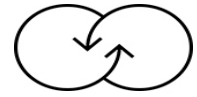

RECYCLABLE

Sizes	600x600 mm, 600x1200 mm, 600x1800mm, 1200x1200 mm Other sizes can be custom ordered *
Thickness	25mm, 30mm, 40mm, 50mm, 75mm
Edges	Square, Bevel, Aluminum, Wooden
NRC	0.9-1
Density	96-150 kg/m ³
Humidity Resistance	RH 90%
Finish	Fabric Wrapped / Spray Painted
Primary Material	High Density bio soluble resin bonded soft fiber glass wall absorber

TECHNICAL DATA

NRC CHART

SERENITY ACOUSTIC PANELS - SOUND ABSORPTION COMPARISON AT VARIOUS THICKNESSES

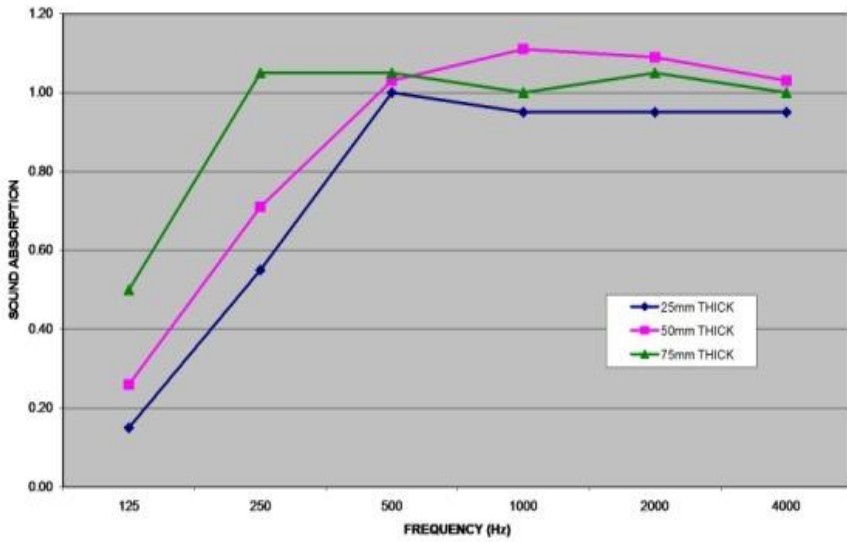

TYPES OF EDGES

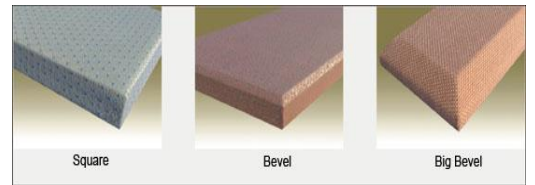

FABRIC COLOUR OPTIONS



JTCR-10



JTCR-20



JTCR-30



JTCR-40



JTCR-50



JTCR-60



JTCR-70

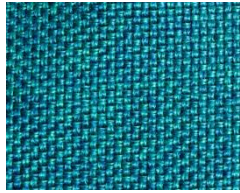

JTCR-90

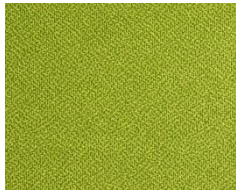

JTCR-100



JTCR-130



JTCR-170



JTCR-200

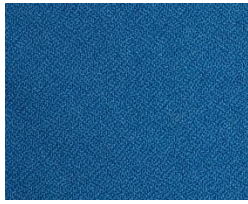

VCR-1001

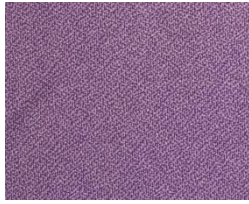

VCR-8101

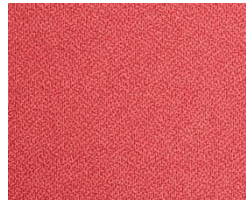

VCR-3101



VCR-2301



VCR-4201



VCR-3201

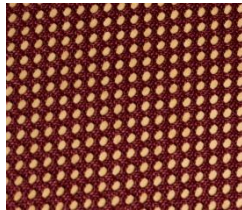

VCR-7001



VCR-8001

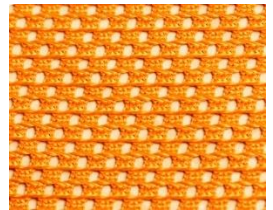

MCR-60



MCR-10



MCR-30



MCR-80



MCR-41



ENCR -718



ENCR-428



ENCR-118



ENCR-408



ENCR-128



NTCR-10



NTCR-20



NTCR-40



3DRCR



3DGCR



INSTALLATION

CREDA ACOUSTIC WALL PANEL CAN BE EASILY INSTALLED OVER EXISTING WALL WITH SURFACE MOUNT IMPALERS OR DIRECTLY OVER WALL WITH AN ADHESIVE.

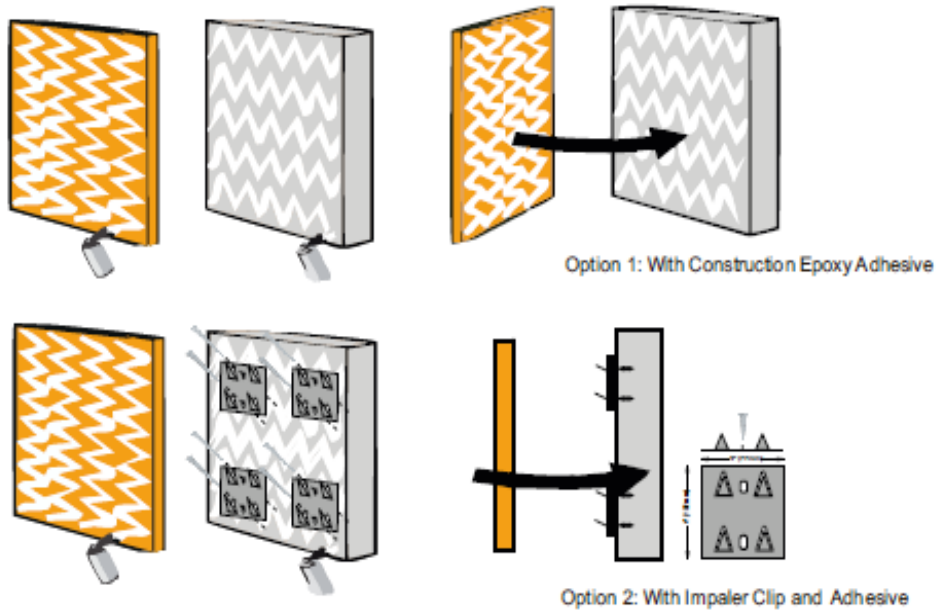

OPTION- 1 INSTALLATION WITH ADHESIVE

Creda Wall Panel can be affixed to the wall using good quality construction adhesive, as follows:

1. Clean the surface & remove surface imperfections/loose particles to enable greater bonding of the adhesive
2. Mark the location of each panel on the wall
3. Apply adhesive using spray gun or by brush smoothly on the back of the panel and on the wall
4. Carefully align the wall panels on the marked location on the wall and press the panel against the wall till it is fixed tightly.

OPTION- 2 INSTALLATION WITH SURFACE IMPALER:



Creda Wall Panel can be affixed to the wall using surface Impalers, as follows:

SURFACE IMPALER

Mark & Screw the surface impalers in distance of approximately 4 inches or 101 mm from the edge of the panel.

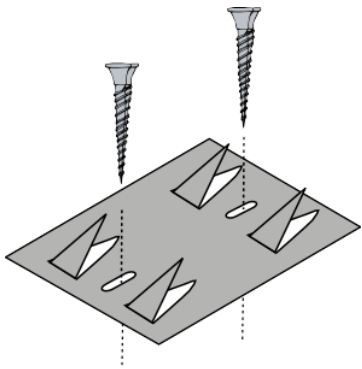

SCREW THE IMPALER

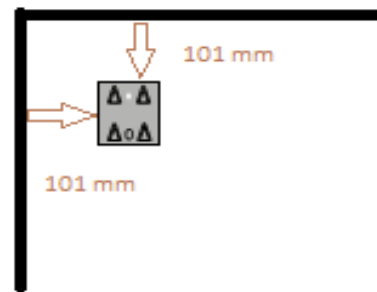

MARKING OF THE IMPALER

Apply adhesive by brush smoothly on the spikes of the Impalers, place & set the panel as per distance made from the edges of the panel, use inward & downward pressure on the panel so that spikes get inserted completely in the panel's back ensuring line & level of panel is maintained.

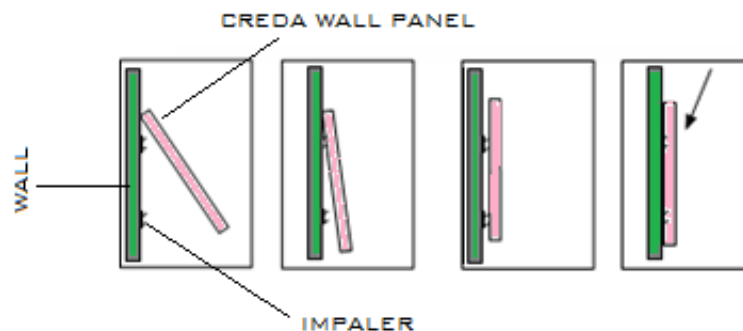

FIXING OF PANEL ON IMPALERS

APPLICATION & REQUIRED VOLUME

FOR OFFICE &
COMMERCIAL SPACE

15-25 % Wall paneling
of CREDA is sufficient
for a noise free
environment of work
place to enhance the
work capability





FOR HOME THEATER

35-50 % Space is sufficient for the small home theater, Studio to maintain good sound effects within the premises

FOR AUDITORIUMS & CINEMA HALLS

50 -75 % coverage of the CREDA wall panel is sufficient to maintain the required reverberation time



MAINTENANCE

THE MAINTENANCE INSTRUCTION & RECOMMENDATIONS TO REMOVE DUST, PEN MARKS, STAINS ARE AS FOLLOWS –

- ✓ USE SMOOTH BRUSH OR VACUUM CLEANER FOR ANY TYPE OF DUST OR DIRT PARTICLES. ENSURE TO CLEAN IN ONE DIRECTION ONLY.
- ✓ USE FRESH GOOD QUALITY CLEANER FOR REMOVING PEN MARKS OR SMUDGES. ENSURE TO CLEAN IN ONE DIRECTION ONLY.
- ✓ USE VOLATILE SOLVENT BASED CLEANER FOR OIL BASED STAINS. ENSURE TO CLEAN IN ONE DIRECTION ONLY.

WARRANTY

- ✓ 5 YEARS WARRANTY FOR CREDESCENCE CRED A WALL PANEL

* PLEASE REFER TO WARRANTY DOSSIER FOR WARRANTY CLAUSES & TERMS

CONTACT US

Call us: +91-120-5105463
+91-99900 49959

Email: info@credenceindustries.com , sales@credenceindustries.com

